

EFB 172 x 150 x 50.8 MM SERIES

DIMENSIONS DRAWING

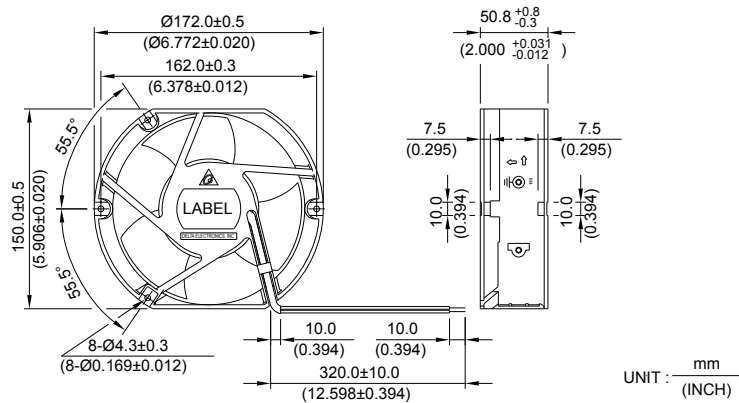

- * Bearing Type
Ball Bearings
- * Material
Impeller : Plastic (UL 94V-0)
Frame: Die-cast Aluminum
- * Lead Wires :
UL 1007 AWG #24 OR Equivalent
Red Wire Positive (+)
Black Wire Negative (-)
- * Weight : 840g (29.62 oz)

P & Q CURVE (AT RATED VOLTAGE)

MOUNTING PANEL CUTOUT

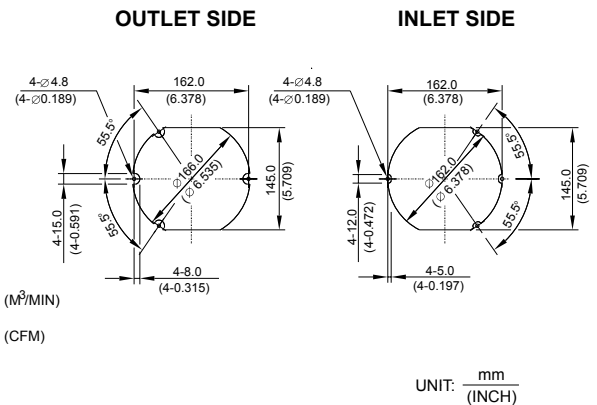
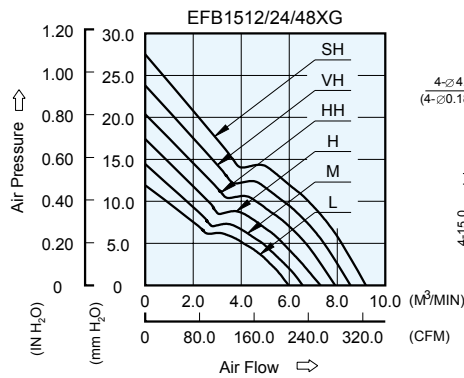

MODEL		Rated Voltage	Operating Voltage Range	Input Current	Input Power	Speed	Maximum Air Flow		Maximum Air Pressure		Noise
PART NO.	FUNCTION	VDC	VDC	Amp	Watt	R.P.M.	m ³ /min	CFM	mmH ₂ O	IN H ₂ O	dB-A
EFB1512LG	-R00 / -F00	12	8.0 to 14.0	0.79	9.48	2800	5.950	210.12	11.90	0.469	50.0
EFB1524LG	-R00 / -F00	24	12.0 to 28.0	0.39	9.36						
EFB1548LG	-R00 / -F00	48	24.0 to 60.0	0.19	9.12						
EFB1512MG	-R00 / -F00	12	8.0 to 14.0	0.99	11.88	3050	6.520	230.25	14.50	0.571	52.0
EFB1524MG	-R00 / -F00	24	12.0 to 28.0	0.47	11.28						
EFB1548MG	-R00 / -F00	48	24.0 to 60.0	0.25	12.00						
EFB1512HG	-R00 / -F00	12	8.0 to 14.0	1.35	16.20	3350	7.130	251.79	17.49	0.689	55.0
EFB1524HG	-R00 / -F00	24	12.0 to 28.0	0.56	13.44						
EFB1548HG	-R00 / -F00	48	24.0 to 60.0	0.31	14.88						
EFB1512HHG	-R00 / -F00	12	8.0 to 14.0	1.79	21.48	3700	7.920	279.69	20.30	0.800	57.5
EFB1524HHG	-R00 / -F00	24	12.0 to 28.0	0.77	18.48						
EFB1548HHG	-R00 / -F00	48	24.0 to 60.0	0.38	18.24						
EFB1524VHG	-R00 / -F00	24	12.0 to 28.0	0.97	23.28	4000	8.560	302.29	23.80	0.937	60.0
EFB1548VHG	-R00 / -F00	48	24.0 to 60.0	0.49	23.52						
EFB1524SHG	-R00 / -F00	24	12.0 to 28.0	1.17	28.08	4300	9.203	325.00	27.50	1.083	63.0

* Function type is optional.
 * The max. air flow and the speed are measured in free air ; max. air pressure is measured at zero air flow.
 * Noise is measured in anechoic chamber in free air, one meter from intake side.
 * All readings are typical values at rated voltage.
 * Specifications are subject to change without notice.